

## ERSATZTEILE

Spare parts · Pièces détachées · Parti di ricambio · Repuestos

配件 · Reserveonderdelen · Запасные части

Bei Ersatzteilanforderung bitte immer die vollständige Ersatzteil-Nr. angeben.  
Hinweis: Für dieses Modell sind nur die unten aufgeführten Ersatzteile erhältlich!

Please order the wanted spare part with the complete spare part item number.  
Note: Only the spare parts listed below are available for this model!

Pour commander des pièces de rechange, ne pas oublier de donner le Numéro d'Article de la pièce demandée. Note: Seules les pièces demandée sont disponibles pour ce modèle!

订购配件时请附上完整的配件号码。注：这个模型，只有以下配件可订购！

121



213



214



215



216



217



218

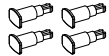

219



220

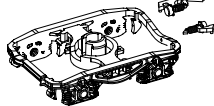

221

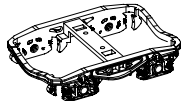

222



223

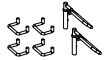

224

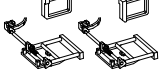

225



226

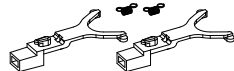

227

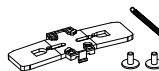

228

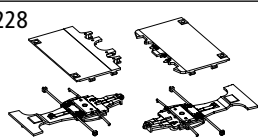

229

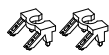

230

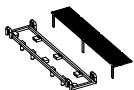

56030



56046



56052

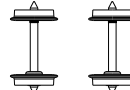

56061

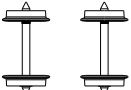

## Taschenwagen T3000e

Pocket Flat car T3000e /

Wagon poche double T3000e /

平板车 T3000e



包装及说明书内包含重要信息, 请保留备用

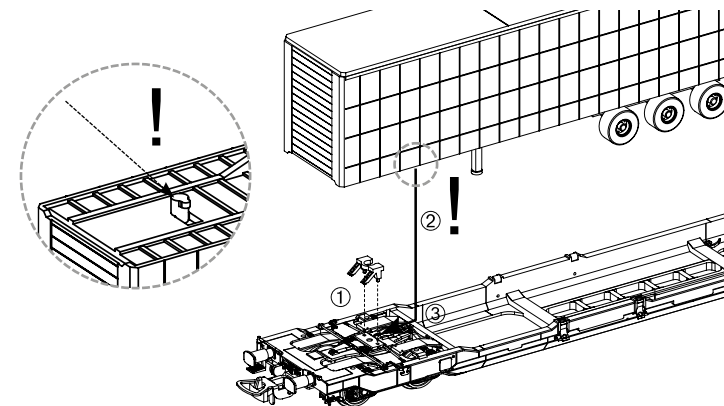
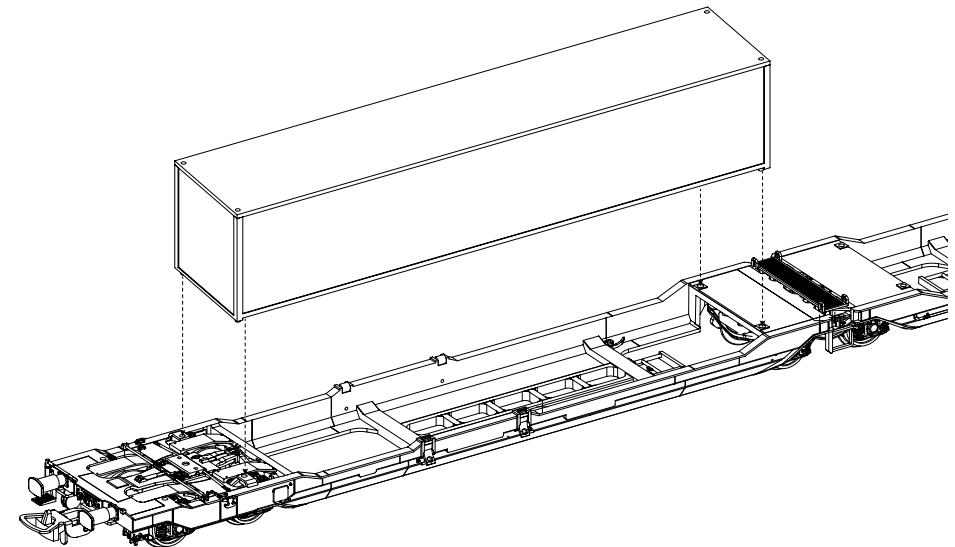

## ERSATZTEILE

Spare parts · Pièces détachées · Parti di ricambio

ET-Nr.:	Bezeichnung:	Description:	Désignation:	Descrizione:	PG*
54000-121	2x Zugfeder	2x Tension spring	2x ressorts	2x molla di trazione	5
54000-213	2x Rangiertritt vorne	2x Step corner	2x Marche pieds avant	2x gradino angolare	6
54000-214	4x Seilanker	4x Rope anchor	4x crochets d'arrimage	4x fissaggio ancoraggio	6
54771-215	2x Bremshebelplatte L / 2x Bremshebelplatte R	2x Brake fitting plate-left / 2x Brake fitting plate-right	2x Support frein gauche / 2x Support frein droit	2x Piastra attacco freno-sinistro / 2x Piastra attacco freno-destro	6
54771-216	4x Hebel ISO Zapfen R / 4x Hebel ISO Zapfen L	4x ISO spigot right / 4x ISO spigot left	4x support contenaire droit / 4x support contenaire gauche	4x punto della leva destra ISO / 4x punto della leva sinistra ISO	7
54771-217	8x Platte ISO Zapfen / 2x Bremse Dako	8x ISO spigot plate / 2x Brake system	8x picots contenaires ISO / 2x détails freinage	8x piastre ISO / 2x sistema freno	7
54771-218	4x Puffer	4x Buffer	4x tampons	4x respingent	6
54771-219	Kessel groß / Kessel mittel / Kessel Restluft	Air boiler big / Air boiler middle / Air boiler-residual air	Grand Réservoir / Réservoir moyen / Détendeur réservoir	Caldaia grande / Caldaia media / Caldaia - aria residua	6
54772-220	Drehgestell vorne / Bremszylinder hinten / Bremszylinder vorne /	Bogie / Brake cylinder rear / Brake cylinder front	Bogie / Cylindre frein avant / Cylindre frein arrière	Carrello anteriore / Cilindro posteriore del freno / Cilindro anteriore del freno	8
54771-221	Drehgestell mitte	Bogie middle	Bogie central	Carrello centrale	7
54771-222	Bremszylinder hinten / Bremszylinder vorne	Brake cylinder rear / Brake cylinder front	Cylindre de frein arrière + avant	Cilindro posteriore del freno / Cilindro anteriore del freno	6
54771-223	2x Rangiergriff / 4x Rangiergriff	2x Handle corner / 4x Handle end	2x poignées / 4x poignées latérales	2x corrimano d'angolo / 4x corrimano terminale	7
54771-224	Rangiertritt mitte R / Rangiertritt mitte L / 2x Stütze	Step middle-right / Step middle-left / 2x Pillar	Marche pied droit / Marche pied gauche / 2x supports	Calpestio centrale destro / Calpestio centrale sinistro / 2x colonne	6
54772-225	2x Luftleitung R / Luftleitung L	2x Pipe right / Pipe left	2x conduit d'air droit / conduit d'air gauche	2x tubo di destra / tubo di sinistra	7
54771-226	2x Kurzkupplung / 2x Feder	2x Short coupler shaft / 2x Spring	2x timons d'attelage / 2x ressorts	2x gancio corto / 2x molla	8
54000-227	Kinematik mitte / Feder / 2x Schraube	Short coupler sheet middle / Spring / 2x Screw	Cinématique centrale / Ressort / 2x vis	Gancio cinematico centrale / Molla / 2x viti	8
54771-228	Übergangsblech A / Übergangsblech B / 2x Sattelauflegerpfanne flach	Transition plate A / Transition plate B / 2x Trailer support flat	Support tôle A / Support tôle B / 2x Supports remorque plat	Passaggio piastra A / Passaggio piastra B / 2x supporti piastra	8
54776-229	2x Sattelauflegerpfanne hoch	2x Trailer support extended	2x Supports remorque haut	2x estensione supporti piastra	6
54000-230	Rahmen für Übergangsgitter / Übergangsgitter	Frame for transition grid / Transition grid	Châssis de ramarde + ramarde	Telaio con griglia di passaggio / Griglia di passaggio	8
<p><b>ET aus unserem Standardprogramm</b>      <b>Spare parts standard range</b>      <b>Pièces détachées de notre gamme standard</b>      <b>Pezzi di ricambio standard</b></p>					
56030	Kupplung (2 Stck.)	Coupling (2 pcs.)	Attelage (2 unités)	Ganci completi (2 pezzi)	
56046	H0 PIKO Kurzkupplung (4 Stück)	H0 PIKO short Coupling (set of 4)	H0 PIKO Attelage (4 unités)	H0 PIKO Ganci (4 pezzi)	
56052	Radsatz DC (2 Stck.)	Wheelset DC (2 pcs.)	Essieux CC (2 unités)	Assali CC (2 pezzi)	
56061	Radsatz AC (2 Stck.)	Wheelset AC (2 pcs.)	Essieux CA (2 unités)	Assali CC (2 pezzi)	

\*Preisgruppe \*price category \*Catégorie de prix \*Gruppo dei prezzi

Repuestos · 配件 · Reserveonderdelen · Запасные части

ET-Nr.:	Descripción:	说明:	Omschrijving:	Описание:	PG*
54000-121	2x muelle	2x弹簧	2x Spanningveer	2x пружины	5
54000-213	2x peldaño de maniobra	2x脚踏-角落	2x Rangeertrede voor	2x подножки	6
54000-214	4x ancla para cable	4x绳锚	4x Zeilanker	4x крюки	6
54771-215	2x Tabla de la palanca del freno I / 2x Tabla de la palanca del freno D	2x制动器安装板-左 / 2x制动器安装板-右	2x Remkoppelingdeksel links / 2x Remkoppelingdeksel rechts	2x Крепёж левый / 2x Крепёж правый	6
54771-216	4x Palanca ISO clavija D / 4x Palanca ISO clavija I	4x栓-右 / 4x栓-左	4x ISO sluitingriem rechts / 4x ISO sluitingriem links	4x ISO заглушка правая / 4x ISO заглушка левая	7
54771-217	8x tabla clavija ISO / 2x sistema de freno	8x栓板 / 2x刹车系统	8x ISO plaatzappen / 2x Rem systeem	8x ISO заглушка плоская / 2x тормозная система	7
54771-218	4x toperas	4x缓冲器	4x Buffers	4x буфера	6
54771-219	Calderín grande / Calderín mediano / Calderín aire residual	气锅-大 / 气锅-中 / 废气缸	Lucht tank groot / Lucht tank achter / Rest lucht tank	Бак большой / Бак средний / Бак расширительный	6
54772-220	Bogie / Cilindro de freno posterior / Cilindro de freno anterior	轮架 / 制动轮缸-后 / 制动轮缸-前	Draaigstel voor / Remzyliner achter / Remzyliner voor	Тележка / Тормозной цилиндр передний / Тормозной цилиндр задний	8
54771-221	Bogie central	轮架-中	Draaigstel midden	Тележка средняя	7
54771-222	Cilindro de freno posterior / Cilindro de freno anterior	制动轮缸-后 / 制动轮缸-前	Remzyliner achter / Remzyliner voor	Тормозной цилиндр задний / Тормозной цилиндр передний	6
54771-223	2x asidero de maniobra / 4x asidero de maniobra	2x扶手-角落 / 4x扶手-端部	2 x Hoek Rangeerhandgreep / 4 x Rangeerhandgreep midden	2x ручка угловая / 4x ручка задняя	7
54771-224	Peldaño maniobra central D / Peldaño maniobra central I / 2x soporte	中间脚踏-右 / 中间脚踏-左 / 2x支柱	Rangeertrede midden rechts / Rangeertrede midden links 2x Pijler	Подножка средняяправая / Подножка средняя левая / 2x уплотнитель	6
54772-225	2x Conducto de aire D / Conducto de aire I	2x管-右侧 / 管-左	2x Luchtleiding Rechts / Luchtleiding Links	2x трубы правые / 1x труба левая	7
54771-226	2x Enganche corto / 2x muelle	2x挂钩杆-短 / 2x弹簧	2x Kortkoppeling / 2x veer	2x шахта сцепного устройства / 2x пружина	8
54000-227	Cinématique central / Muelle / 2x tornillos	片状挂钩-中 / 弹簧 / 2x螺丝	Kortkoppelingsmechaniek midden Veer / 2x Schroef	Сцепное устройство среднее / пружина / 2x винт	8
54771-228	Placa de transición A / Placa de transición B / 2x soporte del tráiler plano	过渡板A / 过渡板B / 2x支撑架-平-拖车	Overgangplaat A / Overgangplaat B / 2 X Trailer draagplaat	Пластина переходника A / Пластина переходника B / 2x поддерживающее устройство	8
54776-229	2x soporte del tráiler alto	2x支撑架-扩展-拖车	2x Trailer plaat extansie	2x держатель трейлера	6
54000-230	Marco para enrejado de paso Enrejado de paso	框架-走板网格 / 走板网格	Raam voor overgangsplaat Overgangsplaat	Сетка с держателем сетки	8
<p><b>Piezas de repuesto estándar:</b>      备用零件的标准范围:      <b>Onderdelen standaardassortiment</b>      <b>Запасные части нашего стандартного диапазона</b></p>					
56030	Enganche (2 p.)	挂钩组件 (2个)	Koppeling (2 st.)	Сцепки (2 шт)	
56046	H0 PIKO Enganche (4 p.)	H0 PIKO 挂钩组件 (4个)	H0 PIKO Koppeling (4 st.)	H0 PIKO Сцепки (4 шт)	
56052	Eje CC (2 p.)	DC轮组 (2个)	Wielstel DC (2 st.)	Колёсная пара DC (2 шт)	
56061	Eje CA (2 p.)	AC轮组 (2个)	Wielstel AC (2 st.)	Колёсная пара AC (2 шт)	

\*Grupo de precio \*价格表 \*Priscategorie \*ценовая категория